

► SKIMMER 17,5L 6° PISCINA POLIESTER / SKIMMER 17,5L 6° POLYESTER POOL

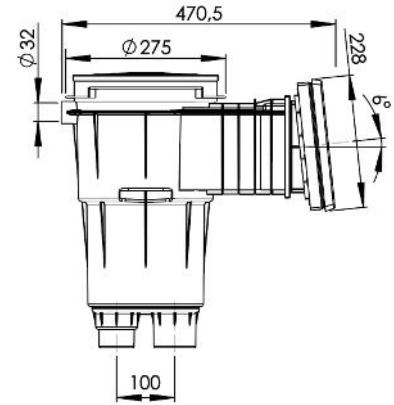

35664

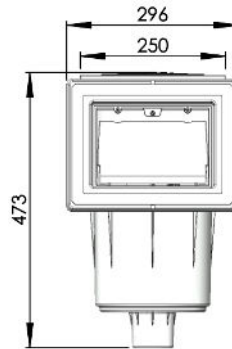

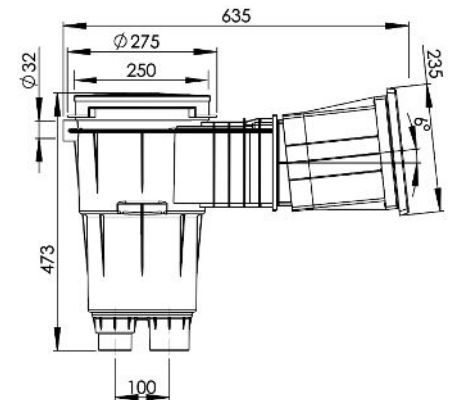
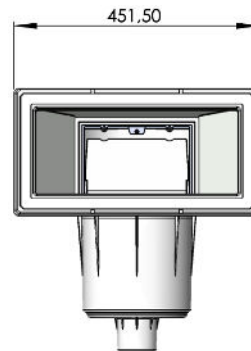









35665

DESCRIPCIÓN DEL PRODUCTO / PRODUCT DESCRIPTION

Skimmers diseñados para instalarse en piscinas prefabricadas de poliéster con un grado de desmoldeo de 6° aproximadamente. Suministrados con juntas adhesivas, marco de bi-inyección bridas y tornillos. Todos los skimmers de la gama tienen tratamiento UV en las partes que no quedan enterradas. Fabricados en ABS blanco, con flotador de compuerta y tapón para regulación de caudal. Conexión inferior de aspiración: rosca interior 1 1/2", exterior 2". Conexión simultánea al sumidero: Ø interior 50mm. Conexión superior de evacuación de agua sobrante Ø 40mm. Cesto recogehojas fijado a la base mediante cierre por bayoneta. Caudal recomendado 7,5 m³/h. Se recomienda instalar un skimmer por cada 25 m² de superficie de lámina de agua.

Skimmer designed for prefabricated pools with inclination 6° approximately. Supplied with adhesifs O'rings, bi-injection face plate, flanges and screws. All range skimmers parts are UV resistant. Made in white ABS, with silent weir flap and flow regulation plug. G 1 1/2" female - G 2" male suction connections. Connection to the main drain with Ø50 mm. Overflow connections Ø40 mm. BAsket secured to base with bayonet fixing. Recommended flow 7,5 m³/h. We recommend installing one skimmer for every 25 m² of water surface.

► CARACTERÍSTICAS TÉCNICAS / TECHNICAL CHARACTERISTICS

CARACTERÍSTICAS CHARACTERISTICS	35664	35665	68108
Tipo de boca Type of throat			
Forma tapa Lid form			
Conexiones inferiores Bottom connections	1 1/2" - 2"		
Caudal recomendado Recommended flow rate	7,5 m ³ /h		
Superficie recomendada Recommended surface	cada 25 m ² every 25 m ²		
Color Colour			 CL129  CL144

► LOGÍSTICA / LOGISTICS

EMBALAJE Y PALETIZADO / PALLETIZED AND PACKAGING						
Código - Code	35664 - 68108			35665		
Medidas caja (mm) - Box sizes (mm)	a	b	c	a	b	c
		300	480	440	460	610
Unidades / Caja - Units / Box	1			1		
Volumen / Caja (m ³) - Volume / Box (m ³)	0,063			0,137		
Peso / Caja (Kg) - Weight / Box (Kg)	6			6,12		
Medidas palet (mm) - Pallet sizes (mm)	a	b	c	a	b	c
	1000	1200	2270	1000	1200	2400
Unidades / Palet - Units / Pallet	28			16		
Volumen / Palet (m ³) - Volume / Pallet (m ³)	2,724			2,88		
Peso / Palet (Kg) - Weight / Pallet (Kg)	183			96		

► CAJA / BOX

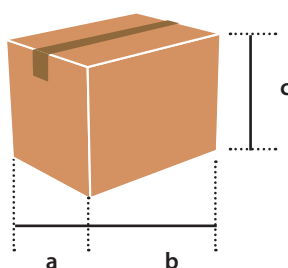

► PALET / PALLET

